

WÓZEK WARSZTATOWY Z ZESTAWEM NARZĘDZI STAHLWILLE



Zestaw TCS 208 narzędzi STAHlwILLE

- Zestaw kluczy płasko-oczkowych z grzechotką
- Szczypce zaciskowe
- Zestaw kluczy płaskich i płasko-oczkowych
- Zestaw szczypiec do pierścieni Segera
- Zestaw narzędzi ślusarskich
- Zestaw kluczy płasko-oczkowych z grzechotką
- Zestaw wkrętaków i imbusów
- Zestaw narzędzi 1/4", 3/8", 1/2"

- WÓZEK WARSZTATOWY DLA PROFESJONALISTÓW
- NAJWYŻSZE STANDARDY JAKOŚCI

- 5 szuflad do 45 kg z uchwytem blokującym
- wymiary szuflady: 475 x 921 mm:
- 3 szuflady o wysokości 90 mm,
- 2 szuflady o wysokości 180 mm
- **górne wykończenie ABS**
- 4 kółka, dwa z przodu wyposażone w hamulce
- w zestawie klucze i zabezpieczenie narożników



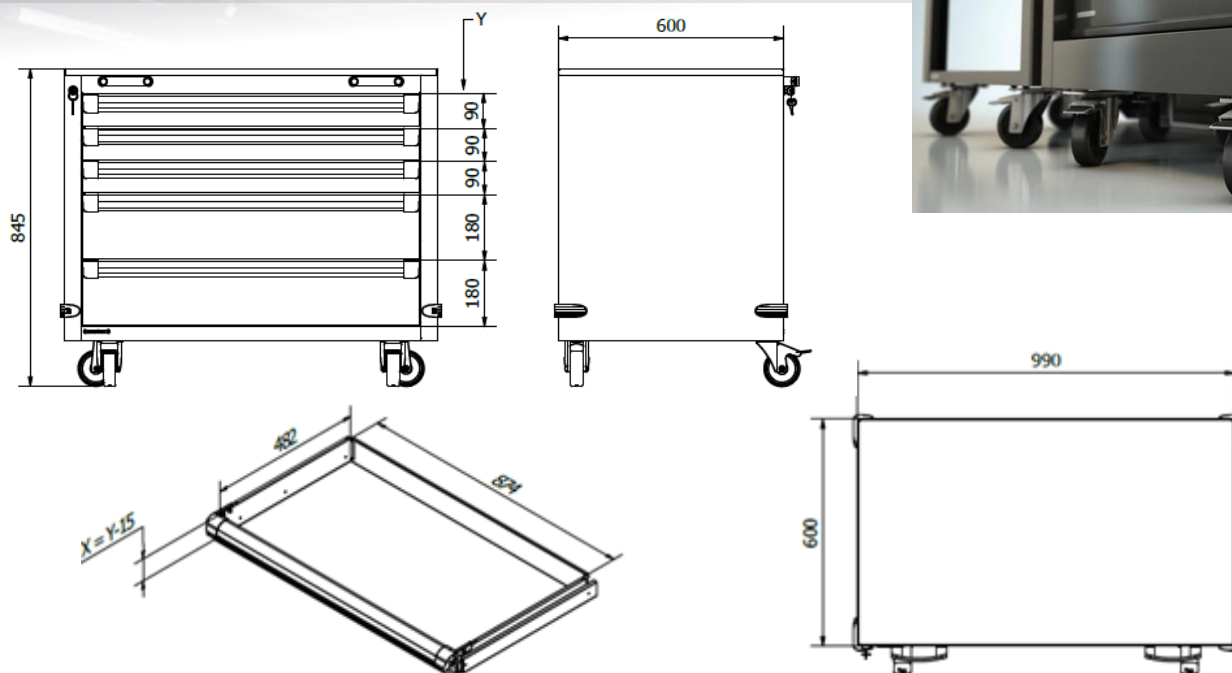

WYMIARY WÓZKA

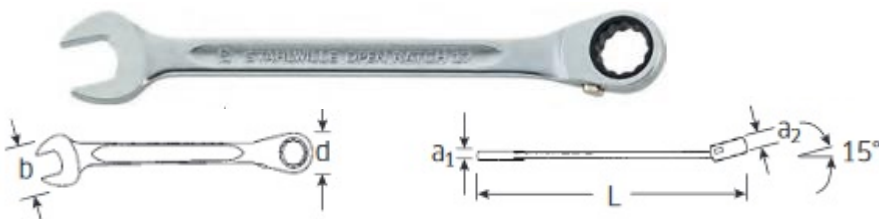

OPEN-RATCH klucze płasko-oczkowe z grzechotką

- Przetłaczane
- Z podwójnym sześciokątem
- 72 zębów
- Kąt pracy 5°
- Końcówka oczkowa odchylona 15°
- Stal stopowa chromowana



Kod	 mm	L MM	b mm	d mm	a ₁ mm	a ₂ mm	g
41170808	8	144	17,0	18,0	4,7	7,4	45
41170909	9	150	18,8	19,5	5,3	7,4	54
41171010	10	158	21,7	21,0	5,7	8,4	65
41171111	11	165	23,0	22,0	6,12	8,4	71
41171212	12	173	25,2	23,5	6,4	8,4	85
41171313	13	182	26,5	25,0	6,6	8,4	94
41171414	14	190	29,5	26,5	7,3	8,4	117
41171515	15	202	31,3	28,0	7,5	8,4	131
41171616	16	215	33,4	29,0	7,7	10,0	156
41171717	17	229	36,3	30,5	7,9	10,0	178
41171818	18	240	38,0	32,0	8,4	11,5	212
41171919	19	252	39,0	34,0	8,7	11,5	235
również w 21, 22 i 24 mm							

ZESTAW kluczy oczkowych TCS 20/10, 6x7-30x32 cm



- 10 elementów

Kod		
96830166		
	Nr	Zawartość
	20	6x7, 8x9, 10x11, 12x13, 14x15, 16x17, 18x21, 19x22, 24x27, 30x32 mm

Szczypce zaciskowe

- Kute szczęki półokrągłe
- Dźwignia zwalnijająca
- Obcinak do drutu, stal chromowo-wanadowa

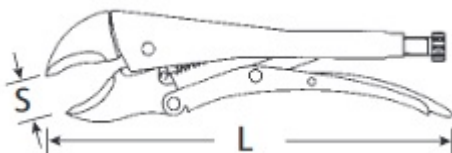



Kod	L mm	S mm
65642250	250	40

Zestaw kluczy płaskich i płasko-oczkowych





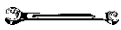

- 30 elementów

Kod 96830605		
	Nr	Zawartość
	10	6 x 7; 8 x 9; 10 x 11; 12 x 13; 14 x 15; 16 x 17; 18 x 19; 20 x 22; 21 x 24 mm
	13	6; 7; 8; 9; 10; 11; 12; 13; 14; 15; 16; 17; 18; 19; 21; 22; 24; 27; 30; 32 mm
	24	10 x 11 mm

Zestaw szczypiec do pierścieni Segera









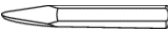

- 4 elementy

KOD ZESTAWU: 96830608	Nr produktu	Opis
	65434002	J2 180 mm
	65444021	J21 170 mm
	65454002	A2 180 mm
	65464021	A21 170 mm

Zestaw narzędzi ślusarskich

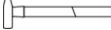

- 18 elementów

ZAWARTOŚĆ	Nr produktu	Opis
	102	150 mm
	103	150 mm
	105	120 x 10 mm
	108	150x3; 150x4; 150x5; 150x6; 150x8 mm
	10956	50 mm
	10961	300; 500 g
	10672	20x315 mm
	12374	
	12900N	150 mm / 6''
	12965N	

Zestaw kluczy płasko-oczkowych z grzechotką











- 12 elementów

Kod		
96830649	Nr	Zawartość
	17	8; 9; 10; 11; 12; 13; 14; 15; 16; 17; 18; 19 mm

Zestaw wkrętek i imbusów















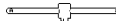

















- 24 elementy

96830706	Nr	Zawartość
	4628	rozmiar 1 (0.4 x 2.5 x 60 mm)
	4724	rozmiar 2 (1.0 x 5.5 x 25 mm)
	4734 4744	PH2 PZ1
	4820	0.6 x 3.5 x 75 mm 0.8 x 4.0 x 100 mm 1.2 x 6.5 x 150 mm 1.6 x 10.0 x 200 mm 2.0 x 12.0 x 250 mm
	4830 4840	PH1; PH2; PH3 PZ1
	10767/9	1.5; 2; 2.5; 3; 4; 5; 6; 8; 10 mm
	7756	
	12922E	Ø 6 mm

Zestaw narzędzi 1/4", 3/8", 1/2"



96830706	Nr	Zawartość
	40	1/4" Ø 4; 5; 5.5; 6; 7; 8; 9; 10; 11; 12; 13 mm
	40TX	1/4" Ø E8; E10
	44K	1/4" Ø 3; 4; 5; 6; 8 mm
	44KTXB	1/4" rozmiary T8; T10; T15; T20; T25; T27; T30; T40
	400	1/4" Ø 150 mm
	404	1/4" Ø 116 mm
	405/2 405/4	1/4" Ø 54 mm 1/4" Ø 100 mm
	407	1/4" Ø 38 mm
	412	1/4"
	415	1/4"
	45TX	3/8" Ø E8; E10; E12; E14
	49	3/8" Ø 5, 6, 8 mm
	49TX	3/8" Ø T25, T45
	425	3/8" Ø 165 mm
	427/3	3/8" Ø 76 mm
	427/10	3/8" Ø 240 mm
	428	3/8" Ø 46 mm
	431	1/4", 3/8"
	432	3/8"
	435	3/8"
	456	3/8" Ø 8; 9; 10; 11; 12; 13; 14; 15; 16; 17; 18; 19; 20; 21; 22 mm

	52	1/2" Ø 10; 11; 12; 13; 14; 15; 16; 17; 18; 19; 21; 22; 24; 27; 30; 32; 34 mm
	54	1/2" Ø 10; 12 mm
	54TX	1/2" Ø T40, T50, T55, T60
	506	1/2" Ø 300 mm
	509/5	1/2" Ø 130 mm
	509/10	1/2" Ø 255 mm
	510	1/2" Ø 71 mm
	512	1/2"
	513	3/8" 1/2"
	1054TX	1/2" Ø T50; T55
	2054TX	1/2" Ø T40; T45